



ARKANSAS GLASS

(800) 527-4527

WWW.AGCC.COM

In viewing this document you acknowledge Arkansas Glass Container Corporation as the sole owner of the concepts or designs contained herein. You may not duplicate, sell, or otherwise distribute the contents of this document without express permission or license from Arkansas Glass Container Corporation.

Finish: 63-405
Height: 5.33 in
Diameter: 2.68 in
Volume/Overflow: 12.63 fl. oz.

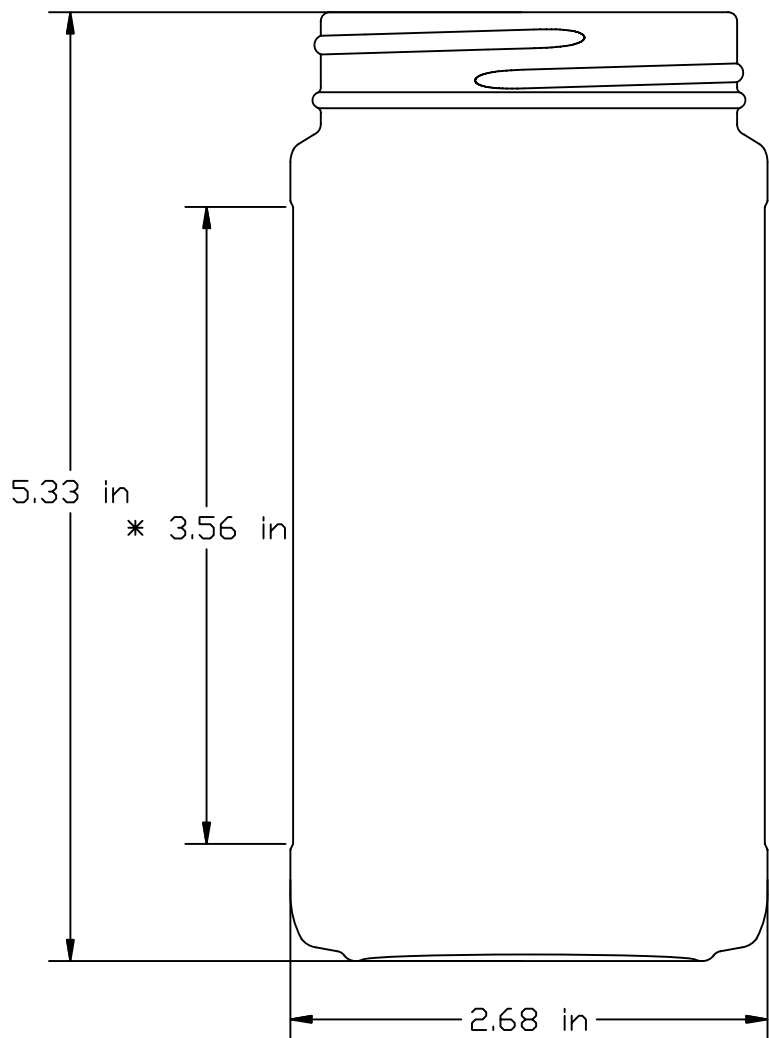

*Note: Maximum label panel shown. It is the customers responsibility to size their label accordingly.

A0012-060C

Document QC-CP-0021-01
Issued: 3/4/2013
Revision: 1

Quantitative values are approximate
Current revision supersedes any previous document